

Agilent E3238 Signals Development System

Product Overview

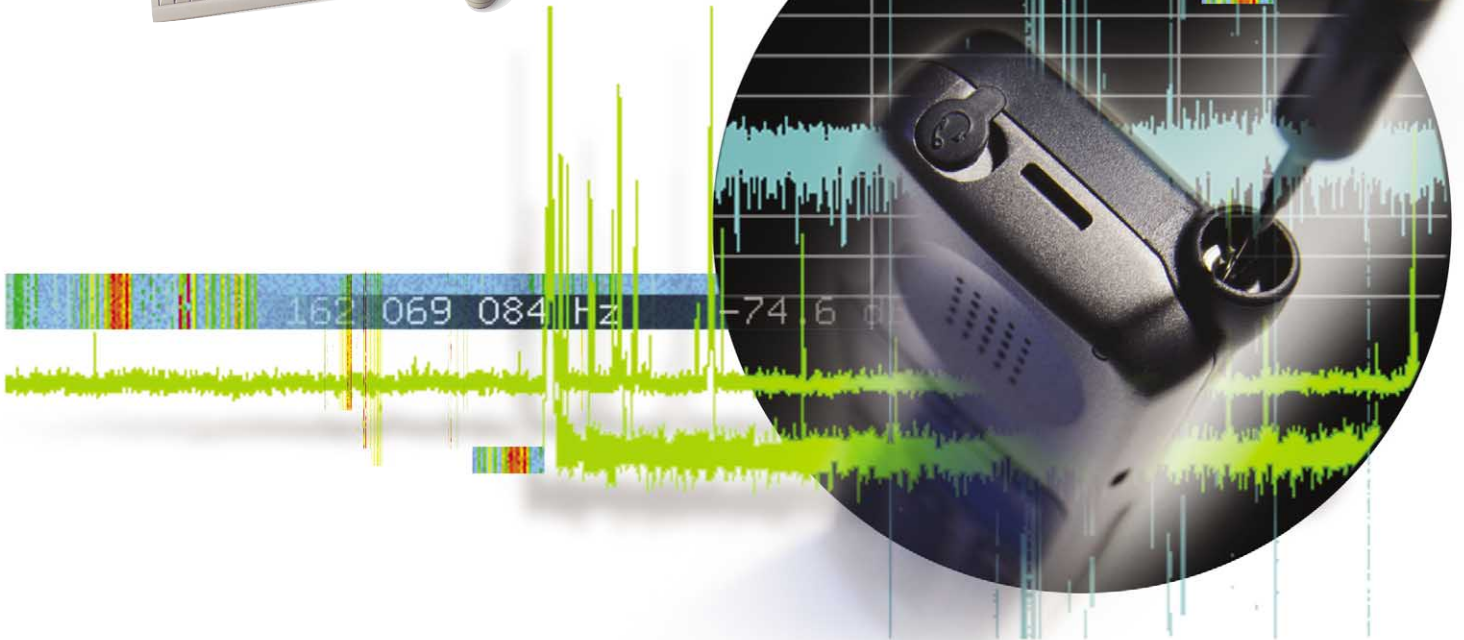

Agilent Technologies E3238 Signals Development System – Deploy Quicker and Produce Faster

The Challenge:

Explosive growth in the wireless communications industries and satellite system technologies poses ever-increasing challenges within the global intelligence community.

Signal surveillance missions today face the difficult task of monitoring the crowded communications spectrum.

Performance

The Agilent E3238 is designed to quickly locate elusive signals. E3238's fast sweep rate and high dynamic range significantly increase the probability of intercept. With the E3238, searches produce more hits quickly and efficiently.

Automation

The E3238 system automates common tasks so an operator can focus on more complex operations, work faster and accomplish more. It allows highly skilled operators to automate functions for less skilled operators. The system can even run unattended.

Adaptability

Optional user-programming software can be used to customize the E3238. Searches can be optimized to capture the signals of interest while disregarding extraneous signals. Displays can also be customized to increase productivity.

Integration

The E3238 can integrate with legacy systems and hand-off receivers. LAN, GP-IB, RS-232, or the VXI backplane can be used to communicate with other hardware. Windows® sockets provide fast communication between software processes, even from remote locations.

Support

Agilent Technologies products are available globally. The E3238 is a commercial product and is easy to buy, maintain, and obtain professional support services.

The E3238 arrives with everything pre-installed and ready to run. Because the E3238 is standards-based, your investment is protected. As technology ramps, so can your system.

Windows NT is a U.S. registered trademark of Microsoft Corporation.

HF Signals Development System

- 0.1–32 MHz frequency coverage
- 6.75 MHz instantaneous bandwidth
- Fast, high resolution spectral search
- Multiple search modes
- Advanced energy thresholds
- New-energy database
- Automated energy alarms
- Hooks for user-programmed functions
- Remote control and data access
- Optional user signal processing

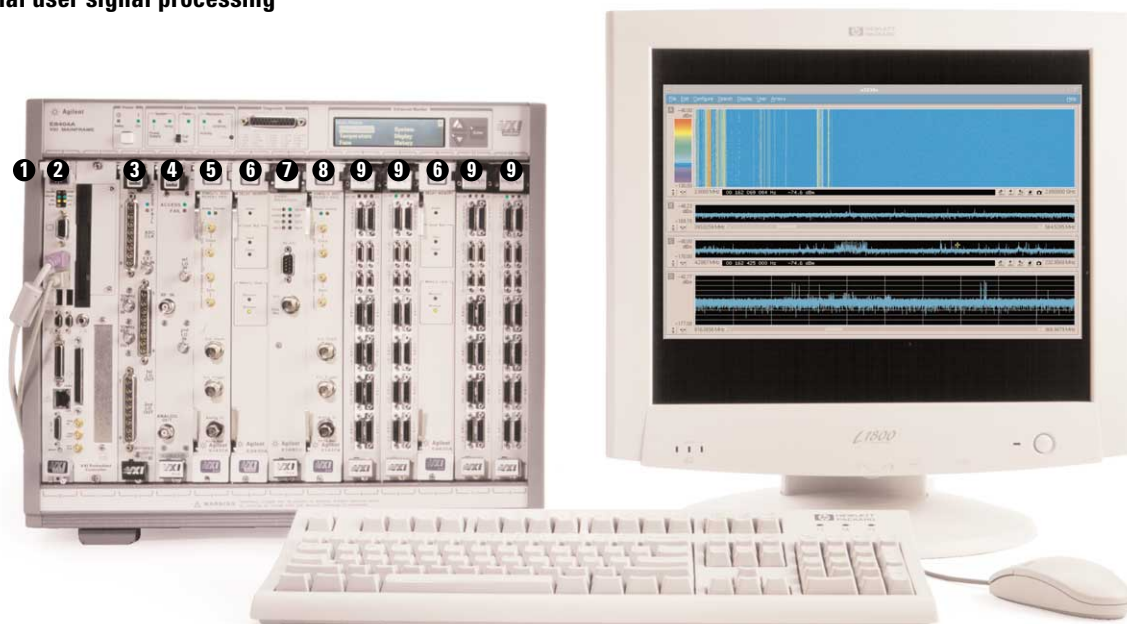

- ❶ E8404A industry standard VXI 13-slot mainframe
- ❷ EMBEDPC1 Windows 2000 system controller
- ❸ WJC9119M - VXI HF tuner (LO section)
- ❹ WJC9119S - HF tuner (RF section)
- ❺ E1437A 20 MSa/sec ADC
- ❻ E9830A 2 GB delay/snapshot memory
- ❼ E9821A DSP
- ❽ E1437A 20 MSa/sec ADC with delay memory
- ❾ SCMVX008 DSP

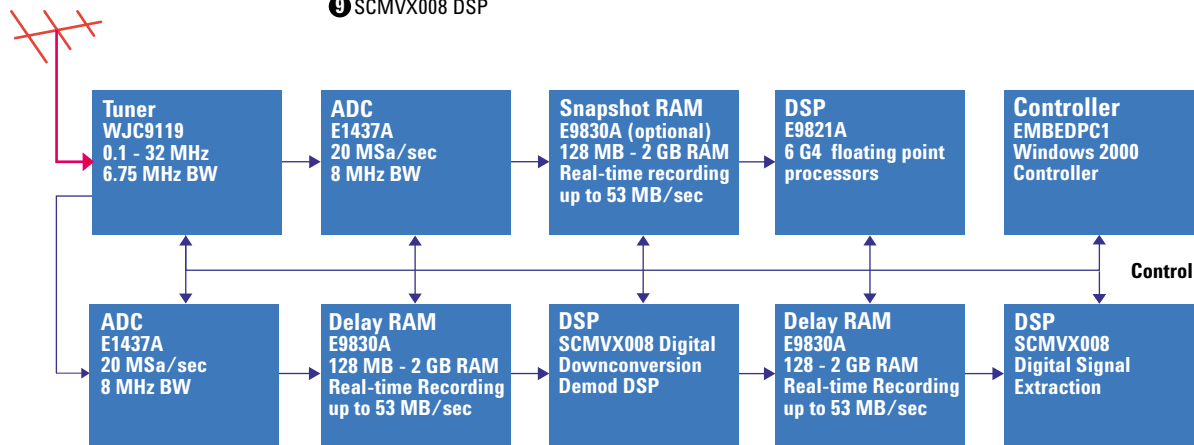

VHF/UHF Search System

- 20–6000 MHz frequency coverage
- 36 MHz instantaneous bandwidth
- Fast, high resolution spectral search
- Multiple search modes
- Advanced energy thresholds
- New-energy database
- Automated energy alarms
- Hooks for user-programmed functions
- Remote control and data access

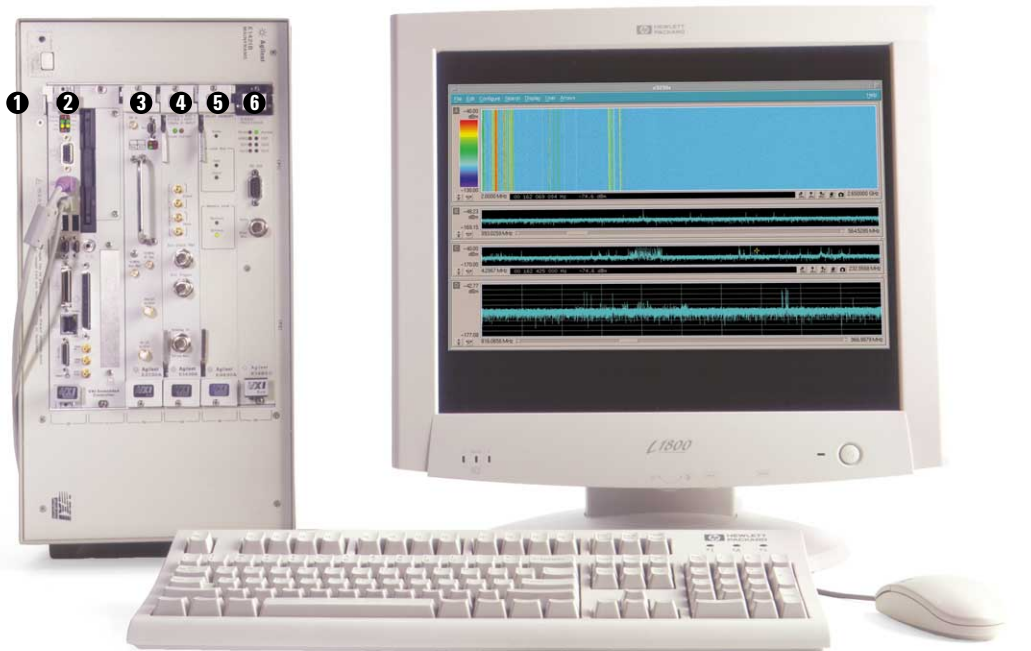

- ❶ E1421B industry standard VXI 6-slot mainframe
- ❷ EMBEDPC1 Windows 2000 system controller
- ❸ E2731A 20–6000 MHz tuner
- ❹ E1439D 95 MSa/sec ADC
- ❺ E9830A 2 GB delay/snapshot memory
- ❻ E9821A DSP

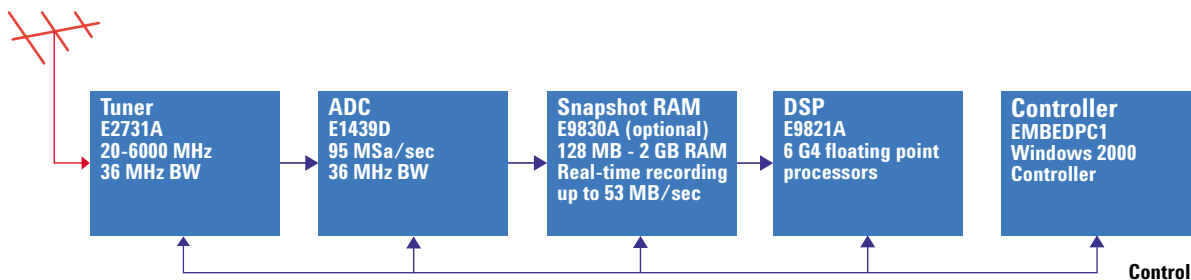

Wide-band search increases probability of intercept

The E3238 uses a wide-band stepped FFT technique to achieve exceptionally fast scanning while maintaining high resolution and wide dynamic range.

The optimum HF system configuration uses an E1437A 20 MHz ADC and WJC9119-tuner. Its 110 dB dynamic range can find small signals even when they are hiding near larger signals.

For the VHF/UHF range the new E2731A 20–6000 MHz tuner and E1439D 95 MSa/sec ADC provide 10 GHz/sec sweep rates and 36 MHz instantaneous bandwidths. End result ... elusive signals will not be missed.

Other VXI and external tuners are available for HF/VHF/UHF and μ wave frequencies. They can be integrated into the system and controlled by the E3238 system hardware.

Tailor the search mode to a specific application

The E3238 has three search modes, each optimized for a particular application.

The general search function can be used to scan and characterize the overall signal environment. In this mode the system sweeps a single spectral region. The operator simply sets the center frequency and span, or start and stop frequencies, and starts sweeping.

The directed search function can sequentially scan multiple separate spectrum segments. This mode scans only the assigned segments, skipping over the spectrum between the segments to improve overall sweep

rate. This can increase probability of intercept for complex search scenarios. It is possible to program up to 100 spectrum segments and store them for quick recall. To accomplish this the operator sets the start and stop frequency, resolution bandwidth, averaging, and revisit ratio for each segment.

The tuner lock search mode can be used to lock the tuner to stare at a single spectrum segment. For the HF system maximum stare bandwidth is 6.75 MHz. For the VHF/UHF system the bandwidth is 36 MHz. This is crucial when using option ASH.

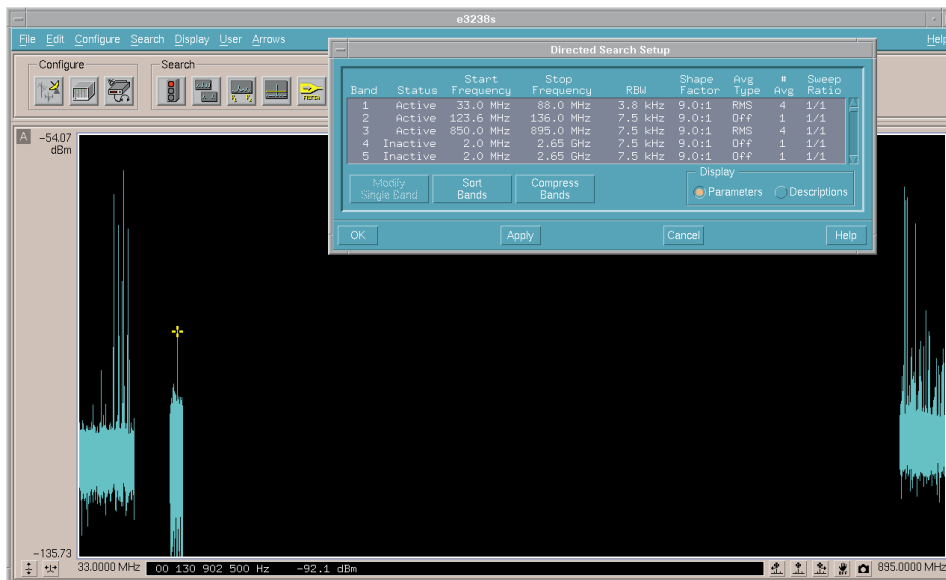

Use the directed search mode to increase your sweep rate by skipping the parts of the spectrum not critical to your mission.

Design for fast operator response

From display types to mouse-driven functions, everything within the user interface of the E3238 is designed to increase an operator's productivity.

Optimized graphical user interface

Dense signal environments challenge even the most skilled operators. The E3238 addresses this problem with an easy-to-use graphical user interface designed to speed signal detection. To set the search span on the E3238, the operator selects the Search Setup pull-down menu and enters the span. Sensitivity, averaging, filter shapes, and the antenna set up can be selected from the same menu.

High-speed displays

Versatile display types with very high update rates show how signals change over time. Multiple displays can reveal a broad view and close up of signals simultaneously. Whether

the signals are stationary or moving, burst or continuous, low-level or high-power, the E3238's spectrum and spectrogram displays have the speed and resolution needed to recognize fine details.

Fast signal evaluation with mouse-based tools

With the E3238 it is possible to select elusive signals by simply pointing, clicking and dragging the mouse over the desired area. The system instantly zooms in on the display of the signal as it continues to sweep. The zoomed display updates on each sweep. It is also possible to set a frequency and amplitude marker with a click of a mouse

Fast assignment of hand-off receivers

Up to 100 hand-off receivers can be controlled by the E3238. Tune the receivers manually with the marker, assign them with drag-and-drop, or have them automatically assigned with alarm functions. It's possible to even use a command line interface if desired. Manual and automatic modes allow the operator to assign monitoring and collection assets to signals of interest.

Software drivers are provided for hand-off receivers from companies such as Signia, Cubic Communications, ICOM, and others.

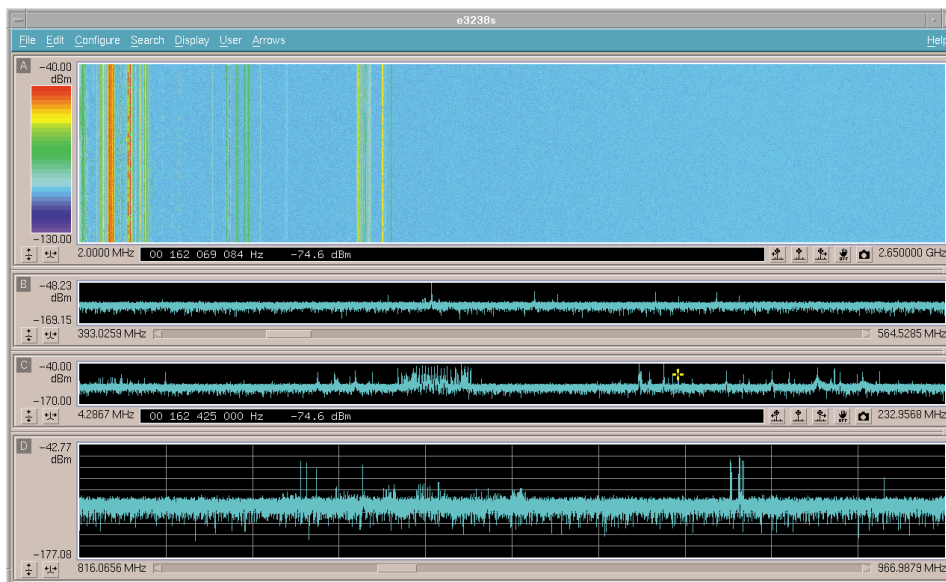

Tailor the way the Agilent E3238 presents signals. Activate up to four displays and show a spectrum trace, full-color spectrogram or two-color spectrogram in each of them, all at the same time.

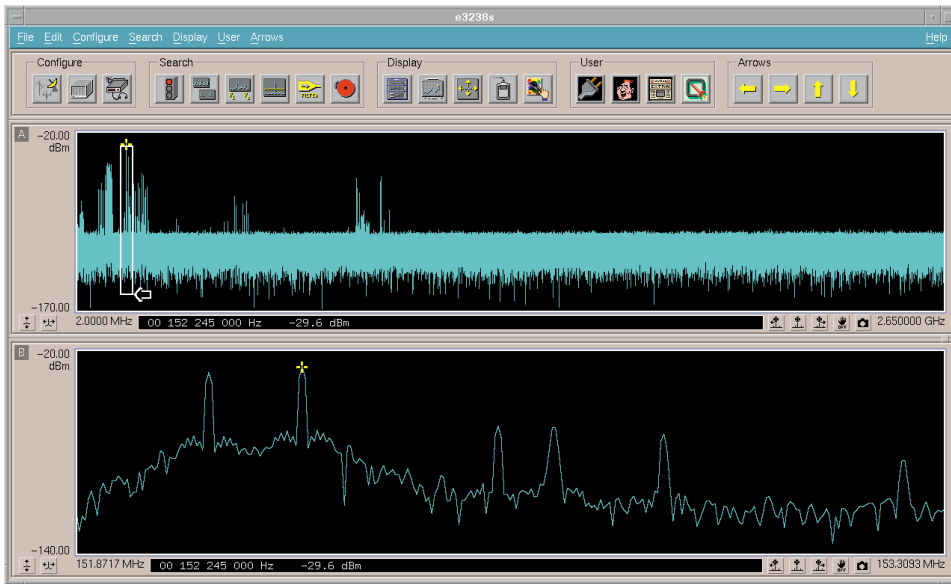

Zooming the display on a signal is simple with the Agilent E3238. It keeps sweeping while the selected area is zoomed. The lower trace shows the zoomed display, the upper is the full measured spectrum.

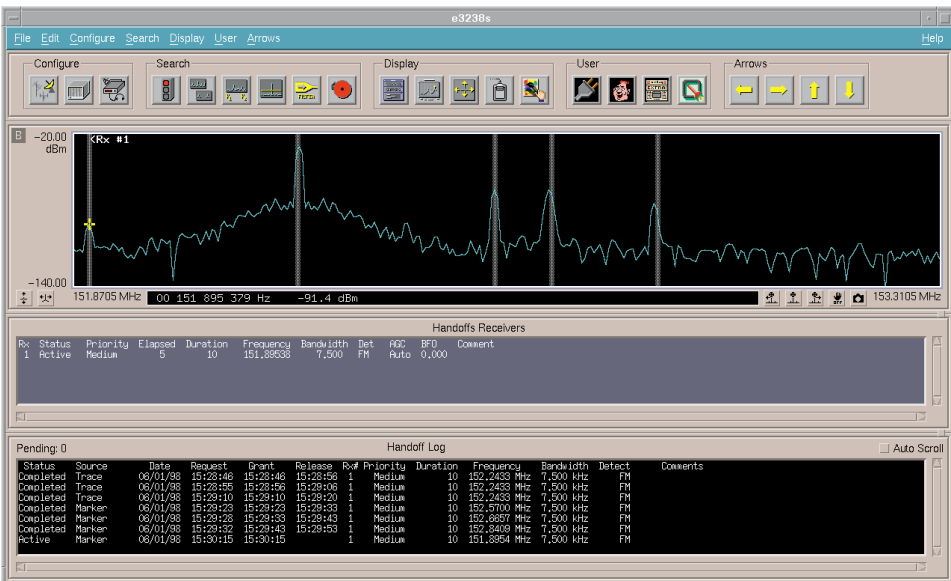

Mouse-based hand-off receiver control makes tuning to a suspect signal quick and simple. The hand-off receiver log automatically lists all the signals examined.

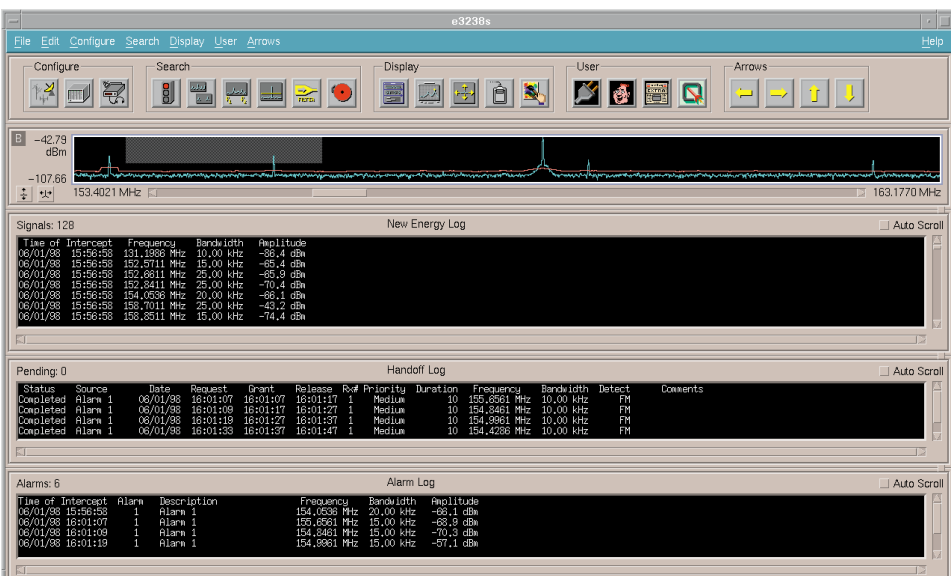

The Agilent E3238 log files maintain an automatic record of mission activities.

Automatically log activities for future reference

The E3238 automatically creates a log to document the mission. Entries are created when new energy is detected, receivers are assigned, or alarms are tripped.

Automation dramatically increases productivity

Automation is the key to increasing signal detection productivity. The E3238 can automatically detect new energy, create a signal database with critical signal parameters, classify the signals, and take action on signals whose parameters meet user-established criteria.

Automatic new-energy detection

Automatic signal classification starts with isolating potential signal energy from noise energy. The E3238 offers three different energy thresholds that automatically separate signal energy from noise energy.

Operators can use the level threshold when the noise floor is flat and reasonably constant. It can be adjusted as close to the noise floor as the task demands.

When the mission is in HF, or anytime the noise floor is contoured or changing, the operator can use auto threshold. This noise-riding threshold is calculated in real time as the E3238 sweeps.

When the dense signal environment masks the arrival of new signals, operators can use the environment threshold. This threshold memorizes the environment on command and subtracts it from the display. The operator only has to monitor the cleared display for new signals. The environment threshold can be saved and used at a later time. Custom environment thresholds can also be built with a text editor or a spreadsheet program.

Automated new-energy history database

The E3238 new-energy history database automatically gathers the data required for classifying signals. It records the features of the signal, including its frequency, bandwidth, amplitude and duration of all energy above the threshold. The database also calculates the minimum, maximum, and average values of the amplitude, bandwidth and duration of each signal, the percent occupancy, and the date and time of the first and last intercept.

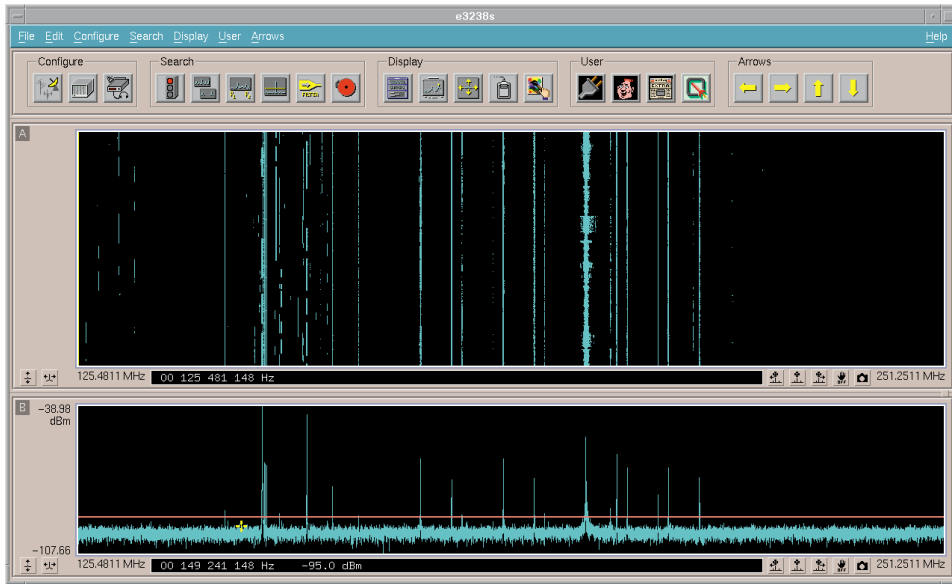

The level threshold is simple and effective with a flat noise floor.

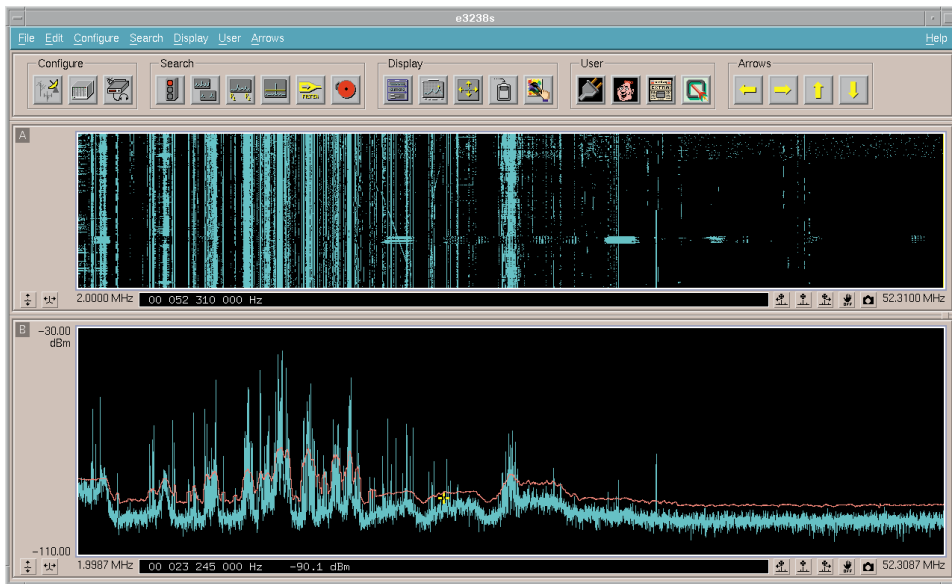

The active noise-riding auto threshold is useful when the noise floor is contoured or changing.

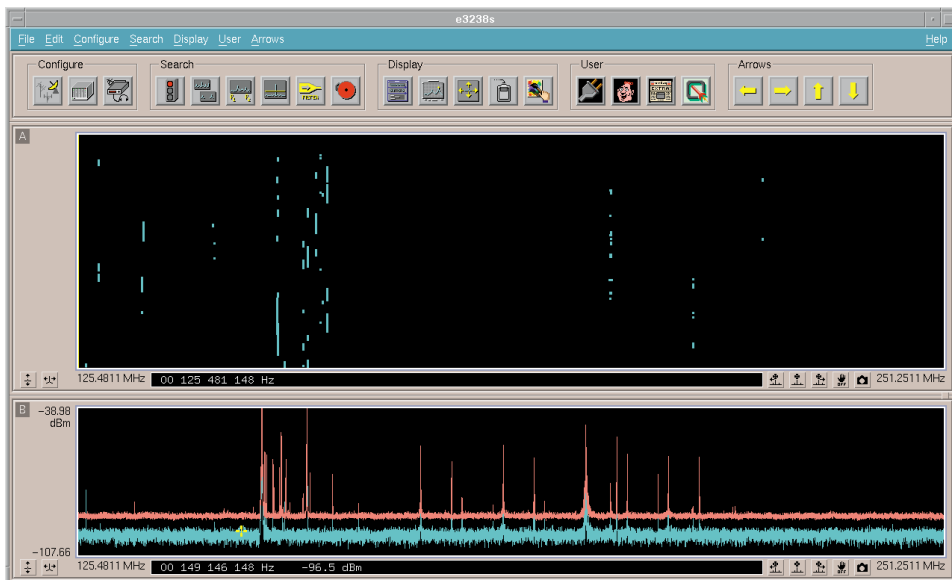

The environment threshold subtracts ambient signals and noise from the Agilent E3238 display and simplifies the task of finding new signals.

Classify energy

The alarms function can automatically identify energy of interest in the energy history database and take action on it. The alarm criteria can be set based on the features of the signal such as:

Signal parameters

Frequency
Amplitude
Bandwidth

Signal state

New signal
Any signal
Signal no longer there

Signal activity

Duration
Intercept time
Occupancy

Select the scheduling that fits the application and have alarms activate automatically. Multiple signal events can be combined into a single alarm.

Take action

The E3238 provides an automatic action function that can be triggered by an alarm. The operator can select the task or tasks to execute from an extensive list of possible pre-determined actions. For example:

- Assign a hand-off receiver to the signal
- Take a snapshot record of the signal with an E9830A
- Store the spectral trace
- Alert the operator with a visual or an audible alarm

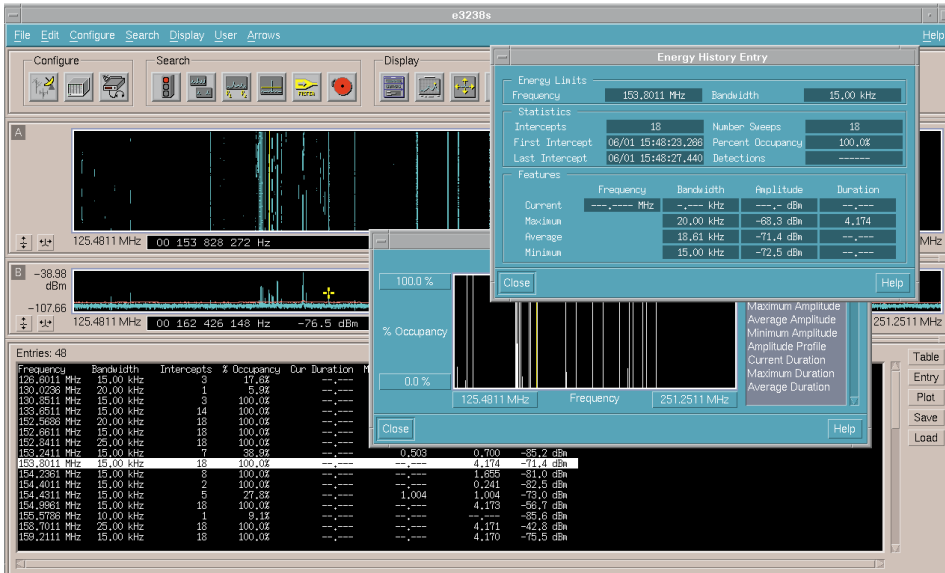

The energy history database automatically stores the parameters of all energy above the threshold. Summary tables, and standard plots are built into this function.

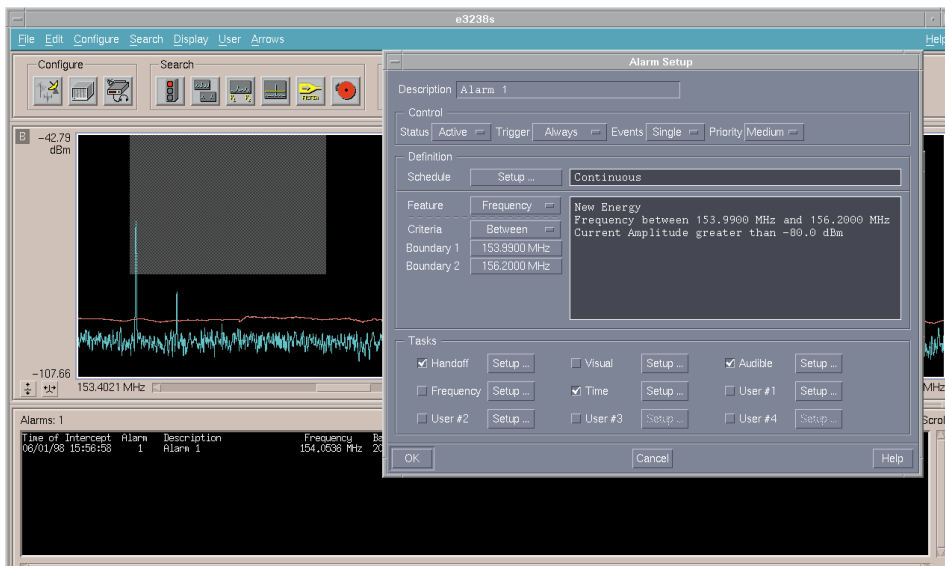

Automatically classify the energy in the energy history database with the alarm function.

Customization

The E3238 may be customized specifically for each application with option AS9 User Programming. Custom energy classification functions, alarm tasks, new displays, macros, and menu items can be created with the customized functions.

Shared libraries simplify software development

Option AS9 adds eight different shared library entry points to make it possible to dynamically link new functions and capabilities into the E3238. C code can be created and linked into the E3238 without having to access the E3238 source code. Software creation is efficient because code is only created for added functionality—no knowledge of the E3238 software is required.

Custom energy classification functions

Operators can create energy history database entries computed from parameters already in the database. For example, it is possible to create a new signal-power parameter, computed from the frequency, amplitude, and bandwidth parameters in the energy history database. This new parameter is automatically included in the energy history database. Once it's in the database, the parameter is accessible by the standard alarms functions. This provides for enhanced automatic energy classification.

Narrow the focus with database filtering

Over time the energy history database can become cluttered with extraneous signals generated by transient noise. The E3238 offers pre- and post-filtering with the addition of option AS9. Pre- and post-filtering are two ways to automatically clean out the energy history database. Fewer signals in

the database reduce alarm function workload and speeds energy detection.

Post-filtering allows signals to be automatically removed from the database if they meet user-selected criteria. For example, false hits may be generated by transient events that are very short duration. To automatically remove them, operators simply write a function to check the percent-occupancy parameter of all the entries in the database and remove all that fall below the limit for valid signals.

Users can create a custom pre-filter to prevent a signal from being included in the database. The pre-filter applies test criteria to the detected signal that must be passed before it is included in the database. Any criteria desired for the pre-filter can be used as long as it's listed in the energy history database. For example, it is possible to compare the signal's frequency spectrum shape to user-defined upper and lower limit lines to determine if the modulation type has the same shape as the target signal.

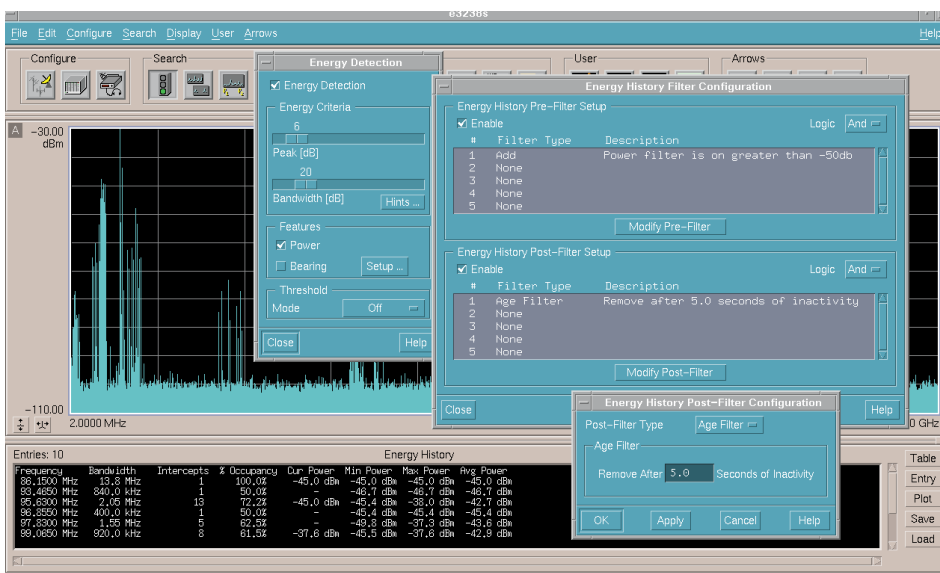

Customize the Agilent E3238 with custom frequency domain based signal feature extractors such as signal power.

Graphical tool generates C software

As mentioned previously, generating the software to create spectrum-based limit lines can be tedious and time consuming. Option ASM Feature Studio is a program with a graphical user interface that automatically generates C code to create limit lines. It can be used to create complex-shaped upper and lower limits to compare to the detected signal's spectrum. Option ASM can actually "learn" its shape from a real signal, then the limit lines can be modified by dragging with the mouse. If the signal is between the limit lines, it is included in the database. This is most often used as a first pass to exclude signals of the wrong modulation type.

Note: ASM can only be used in combination with AS9.

Create custom alarm functions

Customized user tasks can be added to the E3238 alarm function task list with AS9. The E3238 will automatically execute the tasks when new energy meets the alarm criteria. Signals can be passed to a legacy system or to an external tape recorder. Whatever special task is required, option AS9 User Programming will seamlessly link it into the E3238 alarm task list.

AS4 multi-channel search

The AS4 Multiple Channel option allows an AS9 programmer to compare the power spectrums of signals from up to four antennas to determine which antenna a specific emitter is nearer. Up to four tuner/ADC combinations are supported by AS4. A typical application for AS4 is searching for a hidden emitter and determining whether it is inside or outside a building.

Tuning the user interface to meet specific needs

Increase operator efficiency and productivity with custom pull-down

menus and display panes. User programming features can be utilized to modify the E3238's graphical user interface to more closely match operational needs. Operators may combine frequently used control sequences behind a single custom menu pick. A display pane can be created with customized Motif buttons, data tables, and layout. Familiarity with Motif widgets will allow design of custom user displays.

Control special receivers

The E3238 is supplied with drivers for a number of standard hand-off receivers. Custom drivers can be added using the AS9 User Programming option. Interface to the new handoff receivers using the VXI, GPIB, LAN, or RS-232C interfaces, which are standard in the E3238. Once created, the drivers provide full mouse-driven drag-and-drop assignment and manual tuning control of the receivers. Complete compatibility with automatic signal assignment from the alarms feature is maintained as well. All handoff activity is documented in the hand-off receiver log.

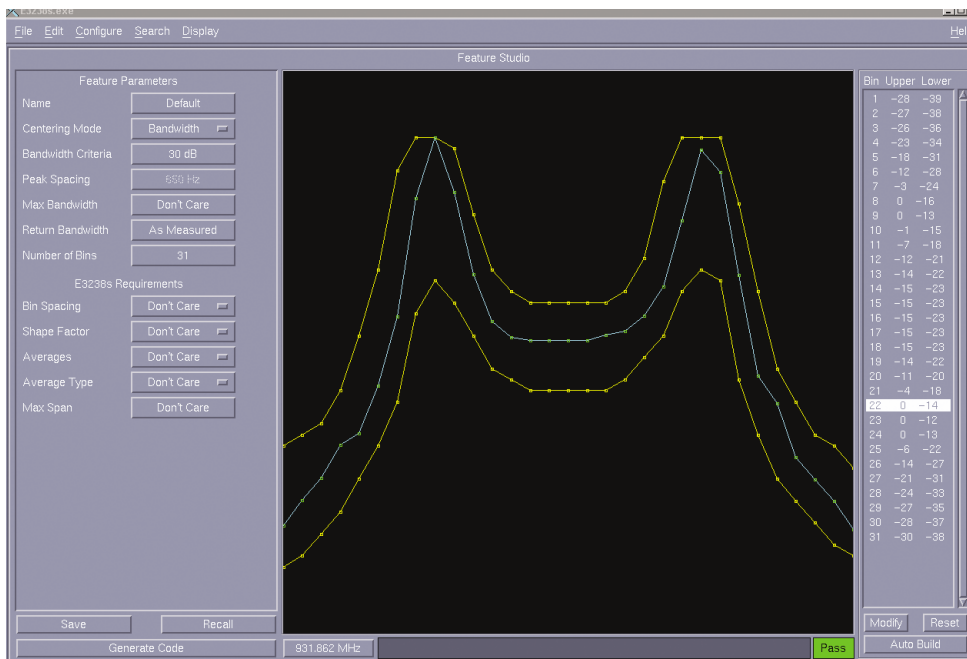

Option ASM can create limit line spectrum shapes from real signal data. C code is automatically generated to implement them.

System integration and remote operation

The E3238 is easily integrated with other systems, whether they are close by or remote. Option AS9 User Programming provides connectivity that ensures tight integration with other systems such as direction finding systems or legacy signal recognition subsystems.

Windows sockets provide the key to E3238 connectivity. The sockets provide reliable, bi-directional, TCP/IP-compatible data flow between computer processes. The processes can be on the same controller, separate controllers, or on an HP-UX workstation and a PC.

Integrating the E3238 with a LAN-based legacy system is simple due to standards-based connectivity and a rich command set. Over 200 commands, included with the E3238, access and set up all the features and functions of the system. Query com-

mands are provided to access system configuration and signal acquisition status. Standard “spew” commands activate several types of data output for system activity monitoring.

The full graphical user interface can be exported and used by a remote client. Operators can access all the E3238 features, displays and menus from any authorized X-compatible client on the network.

In addition to search capabilities, the E3238 can extract the information from a signal of interest. This requires additional VXI hardware and option ASH User Signal Processing software tools.

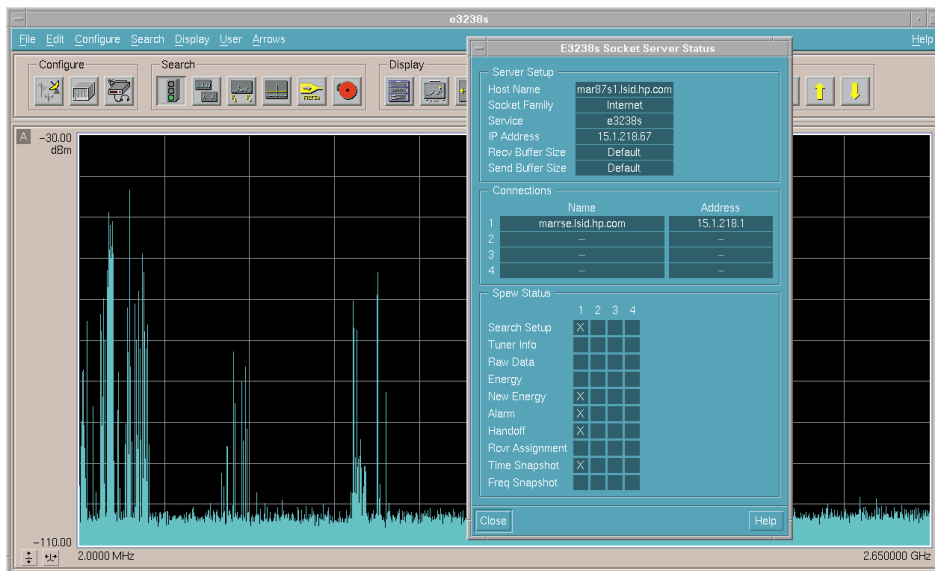

The Agilent E3238 uses sockets for powerful connectivity.

Digital down conversion, demodulation, and signal extraction

User signal processing is the heart of signal extraction

Extracting the information from a signal of interest requires enormous digital signal processing power. First the wide-band analog signal must be digitized. Next digital down-converters extract the narrow-band signal from the wide-band data. Finally, the signal must be demodulated and decoded to extract the information content.

There are hundreds of signal types, some standard and some proprietary. New algorithms must be quickly deployed to keep up with the various new signal types. Option ASH User Signal Processing in the E3238 provides an integrated development environment to create, test, and deploy new signal types. Using the Programming Wizard the user can easily generate a working signal framework, and then drop in their custom signal algorithm. The resulting program can be run on the SCMVX008 DSP module, and is seamlessly integrated with the E3238 system.

Modular, expandable DSP capability

The SCMVX008 has up to ten TMS320C4x DSP chips that can be used to do digital down-conversion, demodulation, and signal extraction. VXI allows multiple SCMVX008s to be assigned to a task, providing a versatile, scalable architecture.

An SCMVX008 can be configured with 16 digital down-converters (digital radios) to handle multiple signals simultaneously. Even with 16 DDCs there is still leftover DSP capability to demodulate the resultant narrow-band signals. For complex signals it is possible to add additional SCMVX008s. A search and collection system may have up to three mainframes. As a result it is possible to construct very high channel count systems.

Catch the first bit of the message with the E9830A RAM Delay Module

By the time the search system identifies a signal of interest, the beginning of the message may have already passed. That is, unless the signal has been delayed before sending it to the SCMVX008. The E9830A RAM Delay Module can have up to 2 GB of DRAM FIFO to delay the signal. Up to 10 E9830As can be used in a system to provide 20 GB of delay memory. By configuring systems with multiple E9830As and SCMVX008s, practically any user task can be accommodated.

DSP programming environment

Option ASH provides a high-level interface to the DSP hardware. When custom DSP algorithms are being created it's unnecessary to worry about hardware control and data movement. The ASH software provides that service.

Development tools

Option ASH programming involves creating software for both the host controller and SCMVX008 DSP module. Microsoft Visual Studio is used and is available from Agilent.

Option ASH SCMVX008 DSP target programs are developed on Windows NT, using the Texas Instruments TMS320C4x code generation tools, also available from Agilent. Optionally, developers can choose to use Texas Instruments' Code Composer—a full-featured DSP development environment, featuring an integrated source-code debugger.

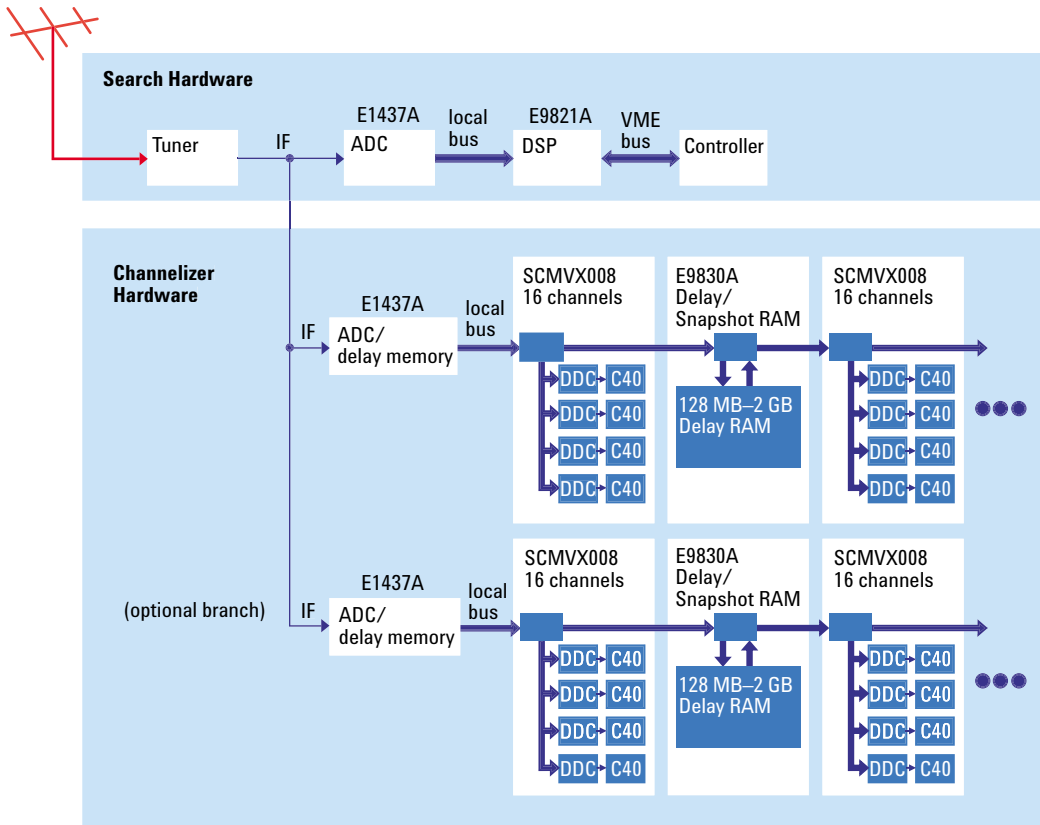

Option ASH channelizer example block diagram.

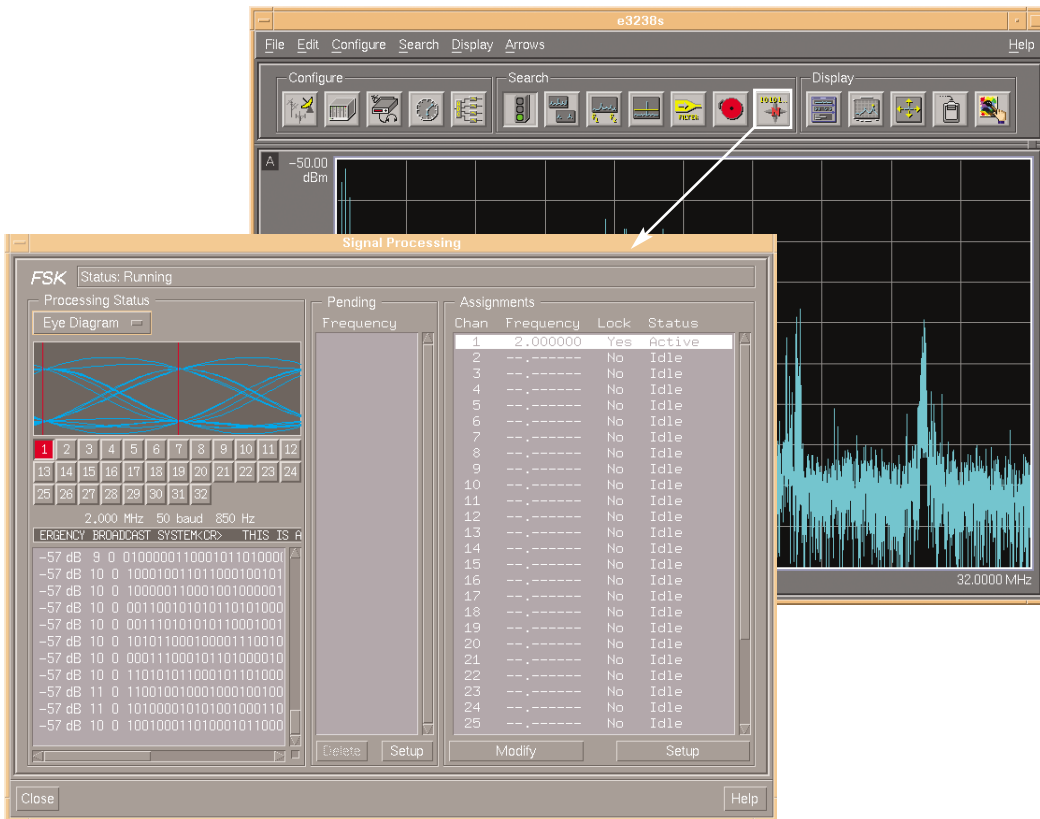

Option ASH example program signal processing menu.

Easy to purchase, easy to maintain

Protect your investment with industry standards

The E3238 is based on industry-standard commercial off-the-shelf VXI hardware. Its modularity allows reconfiguration for different tasks, and provides room for upgrades. VXI (IEEE-1177) extends the capabilities of VME with increased shielding, cooling, and power capabilities.

World-wide support

Agilent Technologies provides full sales and service support. VXI hardware is warranted for three years parts and labor. Extended coverage may be purchased. Software subscription services are available. Software enhancement revisions occur approximately twice a year. For upgrade information, contact your local Agilent Technologies representative.

Factory assembled

The system will arrive with all hardware and software pre-installed, configured and tested.

Ordering information

E3238S	Signals Development System
35688D	E3238 Signals Development System Software
35688D-AS9	User Programming
35688D-ASM	Feature Studio
35688D-ASH	User Signal Processing
35688D-AS4	Multiple Channels
35688D-ORU	Software Subscription Service

Export of the product identified in this literature is subject to U.S. export control laws. Export licenses are approved on a case-by-case basis and sale of any of these products is dependent on approval of the United States government.

Related Agilent Literature

*Agilent Communications
Intelligence Solutions Overview*
literature number 5988-0633EN

*E3238 Signals Development System
Configuration Guide*
literature number 5988-0562EN

*E3238 Signals Development System
Technical Specifications*
literature number 5963-6609E

Visit Our Websites

Agilent Communications
Intelligence Information —
www.agilent.com/find/AD

Agilent VXI Product Information —
www.agilent.com/find/vxi

Agilent Technologies' Test and Measurement Support, Services, and Assistance

Agilent Technologies aims to maximize the value you receive, while minimizing your risk and problems. We strive to ensure that you get the test and measurement capabilities you paid for and obtain the support you need. Our extensive support resources and services can help you choose the right Agilent products for your applications and apply them successfully. Every instrument and system we sell has a global warranty. Support is available for at least five years beyond the production life of the product. Two concepts underlie Agilent's overall support policy: "Our Promise" and "Your Advantage."

Our Promise

Our Promise means your Agilent test and measurement equipment will meet its advertised performance and functionality. When you are choosing new equipment, we will help you with product information, including realistic performance specifications and practical recommendations from experienced test engineers. When you use Agilent equipment, we can verify that it works properly, help with product operation, and provide basic measurement assistance for the use of specified capabilities, at no extra cost upon request. Many self-help tools are available.

Your Advantage

Your Advantage means that Agilent offers a wide range of additional expert test and measurement services, which you can purchase according to your unique technical and business needs. Solve problems efficiently and gain a competitive edge by contracting with us for calibration, extra-cost upgrades, out-of-warranty repairs, and on-site education and training, as well as design, system integration, project management, and other professional engineering services. Experienced Agilent engineers and technicians worldwide can help you maximize your productivity, optimize the return on investment of your Agilent instruments and systems, and obtain dependable measurement accuracy for the life of those products.



Agilent Email Updates

www.agilent.com/find/emailupdates
Get the latest information on the products and applications you select.

By internet, phone, or fax, get assistance with all your test & measurement needs

Online assistance:
www.agilent.com/find/assist

**Phone or Fax
United States:**
(tel) 800 452 4844

Canada:
(tel) 877 894 4414
(fax) 905 282 6495

China:
(tel) 800 810 0189
(fax) 800 820 2816

Europe:
(tel) (31 20) 547 2323
(fax) (31 20) 547 2390

Japan:
(tel) (81) 426 56 7832
(fax) (81) 426 56 7840

Korea:
(tel) (82 2) 2004 5004
(fax) (82 2) 2004 5115

Latin America:
(tel) (305) 269 7500
(fax) (305) 269 7599

Taiwan:
(tel) 0800 047 866
(fax) 0800 286 331

Other Asia Pacific Countries:
(tel) (65) 6375 8100
(fax) (65) 6836 0252
Email: tm_asia@agilent.com

Product specifications and descriptions in this document subject to change without notice.

© Agilent Technologies, Inc. 2003
Printed in USA April 28, 2003

5968-2075E



Agilent Technologies